

Panasonic

ideas for life

LC-P12120

For standby power supplies
 Expected trickle life: 6 years at 25°C
 10 years at 20°C



※Contents indicated (including the recycle marking, etc) are subject to change without notice.

■Dimensions(mm)

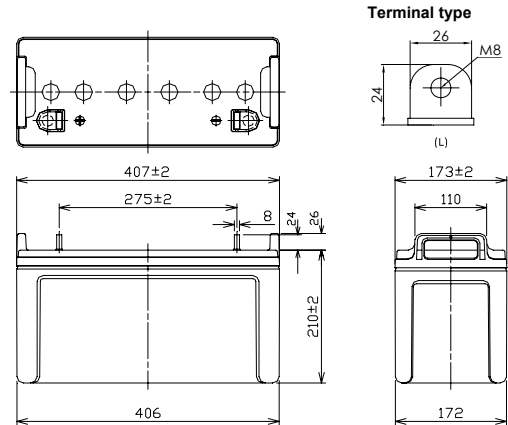

Battery case resin: Flame-retardant (UL94V-0)

■Specification

Nominal Voltage	12V	
Rated Capacity(20HR)	120Ah	
Dimensions	Length	407 mm
	Width	173 mm
	Height	210 mm
	Total height	236 mm
Approx. Mass	34.5 kg	
Terminal	M8 threaded post	

■Characteristics

Capacity (25 °C)	20 hour rate	120Ah
	10 hour rate	109Ah
	3 hour rate	93Ah
	1 hour rate	85Ah
Internal Resistance (25 °C)	Fully charged battery	5 mΩ
Temperature Dependency of Capacity (20 hour rate)	40 °C	102%
	25 °C	100%
	0 °C	85%
	-15 °C	65%
Self Discharge (25 °C)	After 3 months	91%
	After 6 months	82%
	After 12 months	64%

■Duration of discharge vs. discharge current

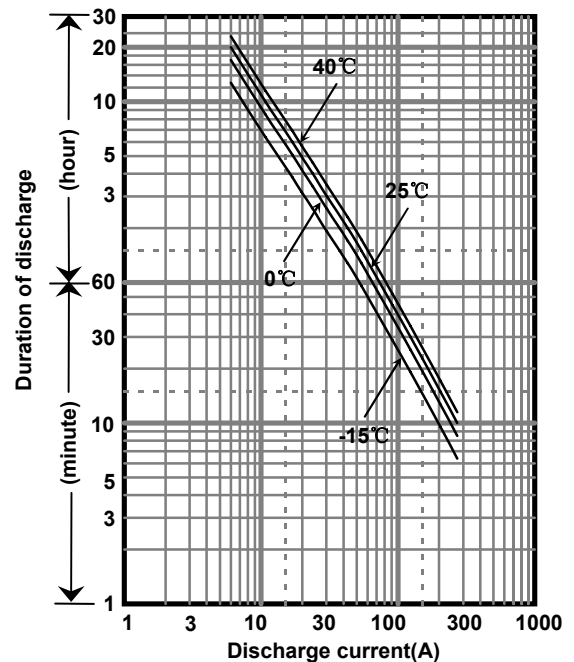

■Watt Table(25°C)

Cut-off V	(Wattage/Battery)														
	5min	10min	15min	20min	30min	45min	1h	1.5h	2h	3h	4h	5h	6h	10h	20h
9.6V	3551	2883	2296	2036	1409	1095	835	663	499	326	261	197	179	104	60.2
9.9V	3488	2849	2285	2024	1370	1062	820	662	486	322	255	191	177	103	60.1
10.2V	3269	2776	2273	2001	1322	1040	805	642	479	315	249	185	168	102	60.0
10.5V	2929	2572	2148	1907	1316	1025	779	629	470	310	246	184	166	101	60.0
10.8V	2589	2294	2079	1861	1281	980	756	559	458	306	240	180	163	99.8	59.9

■Ampere Table(25°C)

Cut-off V	(Ampere/Battery)														
	5min	10min	15min	20min	30min	45min	1h	1.5h	2h	3h	4h	5h	6h	10h	20h
9.6V	361	271	211	181	139	105	86.9	59.3	47.9	32.1	23.7	20.6	17.4	11.1	6.00
9.9V	357	267	210	180	138	102	86.6	58.1	47.5	31.5	23.4	20.4	17.3	11.1	6.00
10.2V	348	261	209	178	136	97.0	85.9	57.7	46.9	31.2	23.2	20.0	17.2	11.0	6.00
10.5V	322	241	198	170	134	92.0	85.4	56.9	46.3	31.3	23.0	19.9	17.1	11.0	6.00
10.8V	282	211	192	165	132	86.9	74.0	51.2	44.0	29.9	22.7	19.8	16.7	10.9	5.88

Charging Method (25°C)

Trickle use	Control voltage:13.6-13.8V Initial current:18.0A or smaller
-------------	--

Cut off voltage

Discharge current	6.00A-24.0A	24.0A-60.0A	60.0A-120A	120A-240A	240A-300A
Cut off voltage(V)	10.5	10.2	9.9	9.3	8.7

Influence of Temperature on Trickle life

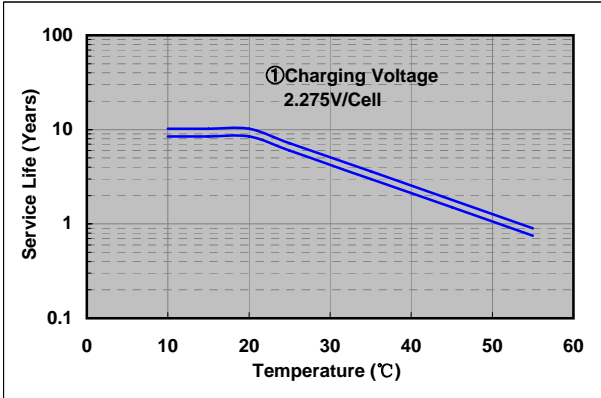

Residual capacity test result

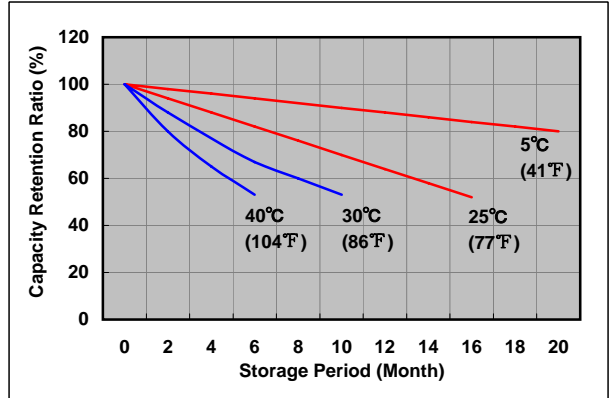

Constant-voltage constant-current charge characteristics for Trickle use

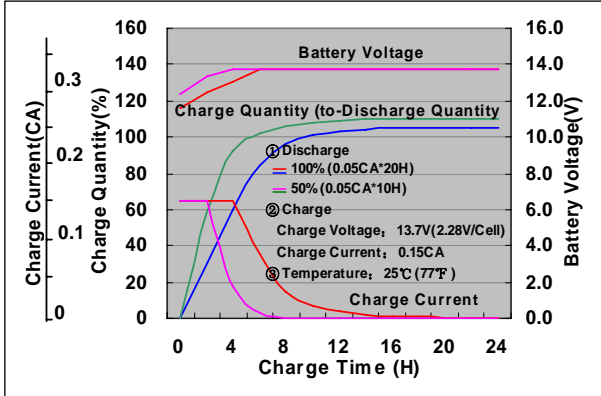

Discharge capacity by temperature and by discharge current

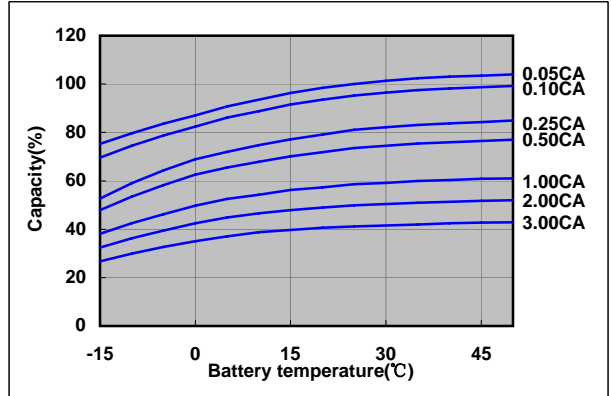

Discharge characteristics(25°C)

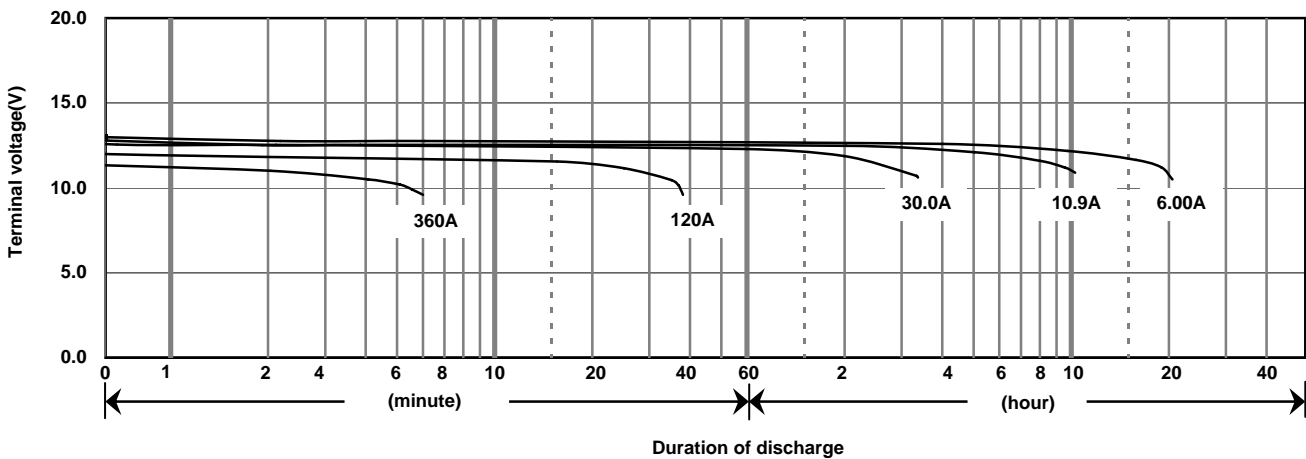

Caution

Due to the potential energy stored in the batteries, Please read 《Precautions for handling the Rechargeable Valve Regulated Lead Acid Batteries》 before using batteries. If improper handling or use of the batteries without understanding 《Precautions for handling the Rechargeable Valve Regulated Lead Acid Batteries》 may result in bodily injury caused by electrolyte leakage, heat generation, or explosion.

Panasonic Storage Battery (Shenyang) Co., Ltd

NO. 51 Kunminghu Street, Shenyang Economic & Technical Development Zone, 110141 China

Tel: 86 24 25818921

Fax: 86 24 62786318

Website: <http://www.panasonicbattery.cn>

2010.03